

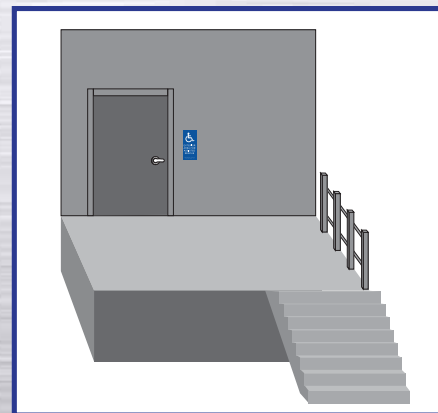

# AREA OF RESCUE SIGNAGE SOLUTIONS

## ADA • Emergency • Wayfinding Signs



## 2024 CATALOG

630-359-5929

[aorsigns.com](http://aorsigns.com)



# AREA OF RESCUE SIGNAGE SOLUTIONS

*Your sign solution partner!*

*Design-Fabrication-Installation*



Clear/Matte —	Bright White L-010-303-A L-010-303 L-010-306 L-010-308	Frost L-010-583-A L-010-583 L-010-586 L-010-588	White L-010-113-A L-010-113 L-010-116 L-010-118	Warm White L-010-563-A L-010-563 L-010-566 L-010-568	Yellow L-010-143-A L-010-143 L-010-146 L-010-148	Gold L-010-123-A L-010-123 L-010-126 L-010-128	Orange L-010-623-A L-010-623 L-010-626 L-010-628	Medieval Copper L-010-423-A L-010-423 L-010-426 L-010-428	Pipestone L-010-533-A L-010-533 L-010-536 L-010-538	
1/32-A* 1/32 1/16 1/8	0-0-0-0 255-255-255 Trans. White	0-0-0-0 255-255-255 Trans. White	3-0-0-1 240-247-251 7541	0-0-0-2 248-248-248 Cool Gray 1	0-1-4-0 255-251-242 Warm Gray 1	0-11-100-0 255-219-0 108	0-29-73-25 198-149-73 4645	0-60-100-0 245-130-32 166	0-58-83-40 162-88-38 1615	0-67-80-42 155-42-34 484
CMYK RGB PMS										
Red L-010-133-A L-010-133 L-010-136 L-010-138	Burgundy L-010-543-A L-010-543 L-010-546 L-010-548	Merlot L-010-523-A L-010-523 L-010-526 L-010-528	Pink L-010-513-A L-010-513 L-010-516 L-010-518	Light Blue L-010-373-A L-010-373 L-010-376 L-010-378	Periwinkle L-010-363-A L-010-363 L-010-366 L-010-368	Slate Blue L-010-493-A L-010-493 L-010-496 L-010-498	Blue L-010-153-A L-010-153 L-010-156 L-010-158	Cobalt Blue L-010-573-A L-010-573 L-010-576 L-010-578	Majestic Blue L-010-403-A L-010-403 L-010-406 L-010-408	
1/32-A* 1/32 1/16 1/8	0-100-90-23 190-19-35 1797	0-92-52-75 94-0-23 216	0-63-21-50 143-73-89 7637	0-81-22-11 216-79-121 213	97-40-0-0 0-125-197 298	49-15-0-6 116-172-214 284	19-4-0-66 93-106-117 5415	100-50-0-39 0-76-130 300	100-70-0-56 0-42-95 662	79-63-0-70 21-35-78 7694
CMYK RGB PMS										
Denim Blue L-010-353-A L-010-353 L-010-356 L-010-358	Spruce L-010-433-A L-010-433 L-010-436 L-010-438	Lagoon L-010-463-A L-010-463 L-010-466 L-010-468	Intense Teal L-010-453-A L-010-453 L-010-456 L-010-458	Mint L-010-443-A L-010-443 L-010-446 L-010-448	Spring Green L-010-173-A L-010-173 L-010-176 L-010-178	Evergreen L-010-183-A L-010-183 L-010-186 L-010-188	Bisque L-010-323-A L-010-323 L-010-326 L-010-328	Almond L-010-203-A L-010-203 L-010-206 L-010-208	Bone L-010-313-A L-010-313 L-010-316 L-010-318	
1/32-A* 1/32 1/16 1/8	69-32-0-78 12-50-79 7463	36-0-28-68 69-97-89 5487	68-0-25-45 20-122-127 7474	83-0-33-47 0-113-116 7475	46-0-49-12 125-183-142 346	94-0-94-3 0-164-84 7724	100-0-72-53 0-98-70 342	0-8-20-4 243-224-196 Warm Gray 1	0-2-16-7 239-231-206 Warm Gray 1	0-4-24-5 244-229-192 Warm Gray 1
CMYK RGB PMS										
Khaki L-010-363-A L-010-263 L-010-266 L-010-268	French Vanilla L-010-343-A L-010-343 L-010-346 L-010-348	Desert Sand L-010-383-A L-010-383 L-010-386 L-010-388	Putty L-010-603-A L-010-603 L-010-606 L-010-608	Latte L-010-333-A L-010-333 L-010-336 L-010-338	Taupe L-010-393-A L-010-393 L-010-396 L-010-398	Aged Bronze L-010-593-A L-010-593 L-010-596 L-010-598	Chestnut L-010-613-A L-010-613 L-010-616 L-010-618	Chocolate Brown L-010-163-A L-010-163 L-010-166 L-010-168	Light Grey L-010-473-A L-010-473 L-010-476 L-010-478	
1/32-A* 1/32 1/16 1/8	0-6-23-23 205-192-164 7734	0-11-35-1 251-222-172 7401	0-13-43-16 218-190-137 453	26-23-33-0 191-184-168 452	0-15-35-38 173-150-119 8021	0-17-29-57 134-115-98 Warm Gray 7	0-46-85-66 114-69-13 161	0-48-55-67 112-67-47 7518	0-41-35-93 50-26-21 439	1-0-9-11 225-226-212 Cool Gray 2
CMYK RGB PMS										
Silver L-010-193-A L-010-193 L-010-196 L-010-198	Oyster Shell L-010-483-A L-010-483 L-010-486 L-010-488	River Clay L-010-503-A L-010-503 L-010-506 L-010-508	Frosted Plum L-010-413-A L-010-413 L-010-416 L-010-418	Charcoal Grey L-010-293-A L-010-293 L-010-296 L-010-298	Graphite L-010-553-A L-010-553 L-010-556 L-010-558	Black L-010-103-A L-010-103 L-010-106 L-010-108				
1/32-A* 1/32 1/16 1/8	0-0-0-0 163-167-167 Cool Gray 7	8-0-13-20 194-203-190 Warm Gray 3	0-3-16-58 134-129-117 Cool Gray 9	0-10-7-74 100-91-91 432	0-7-19-83 82-75-67 411	0-3-7-84 78-75-73 Black 7	29-14-0-100 0-0-0 Black			
CMYK RGB PMS										

**1/32" available for Braille Sign Font Lettering**  
**1/16", 1/8" and 1/4" available for Sign Background Color**  
**High Contrast between lettering and background is recommended.**



## *We can help you create your custom braille signs!*

Your braille sign can be created in:



Call or email us to talk about your project!

\*ADA compliance will be observed before custom options will be applied



# Table of Contents:



**ELEVATOR LANDING SIGNS**  
Pg 6-7

**AREA OF REFUGE**  
Pg 8-9



**AREA OF RESCUE ASSISTANCE**  
Pg 10-11

**AREA OF RESCUE ASSISTANCE**  
EXTERIOR Pg 11

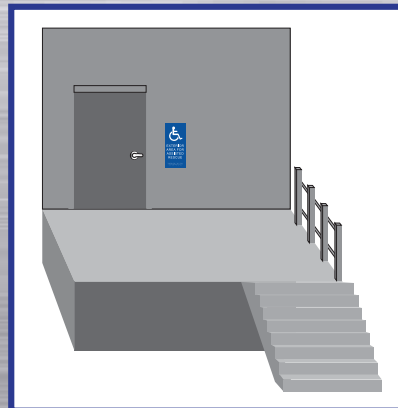

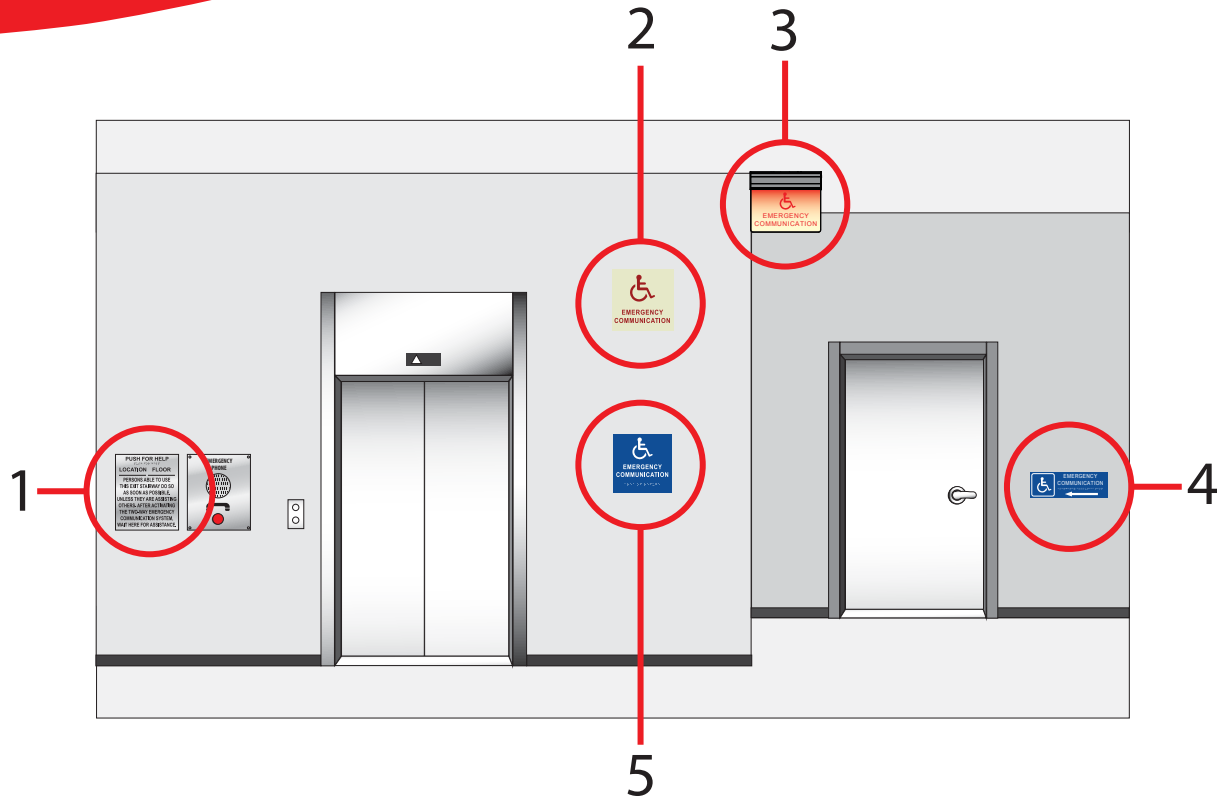

## ELEVATOR LANDING PUSH FOR HELP SIGN

1210PFH

1

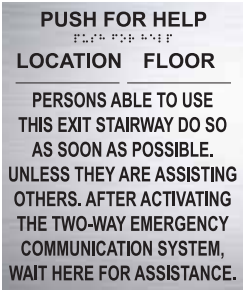

- Dimensions: 12" H x 10" W
- White Finish or Silver Finish
- Raised letters and braille
- All text 5/8" height
- Peel and stick mounting for easy installation
- Sign should be mounted above or adjacent to each Call Box
- Required for each Call Box per IBC Section 1007.1
- IBC, NFPA, ADAAG Code compliant

## ELEVATOR LANDING PHOTOLUMINESCENT SIGN

88ECGLOW

2



- Dimensions: 7-3/4" H x 7-3/4" W
- Peel and stick mounting for easy installation
- Sign should be mounted above 60" but below 80" from floor to top of sign
- IBC, NFPA, ADAAG Code compliant
- Photoluminescent Material Specifications:
  - Base material is PVC and a non-toxic pigment is added to create the photoluminescent effect
  - Material is listed under UL 1994
  - After being exposed to 1 foot candle of light for 60 minutes, a minimum luminance shall be 30 millicandelas per square meter at 10 minutes and 5 millicandelas per square meter after 90 minutes
- Typical material life expectancy is 25+ years



## ELEVATOR LANDING LIT SIGN

1410ECL

3



- Dimensions: 10.5"H x 14"W x 3"D
- Single Sided
- Aluminum housing with acrylic surface
- Mounts to any surface (4 screw holes)
- Power: 120/277vac (4w, 350mA)
- Voltage surge and short circuit protection
- Battery backup
- LED lights
- Constant uniform illumination
- Sign should be mounted above 60" but below 80" from the floor to top of the sign
- Directional arrows included (set of 3)
- UL listed to meet UL 924, NEC, OSHA, NFPA, and Life Safety Code Illumination requirements

## ELEVATOR LANDING TACTILE BRAILLE SIGN W/ARROW

412EC

4



- Elevator Landing Tactile Braille Sign
- Dimensions: 4"H x 12"W
- IBC, NFPA, ADAAG Code compliant
- Raised letters and braille
- Peel and stick mounting for easy installation
- Sign should be mounted between 48" - 60" from floor to lowest tactile characters

## ELEVATOR LANDING TACTILE BRAILLE SIGN

88EC

5



- Elevator Landing Tactile Braille Sign
- Dimensions: 7-3/4"H x 7-3/4"W
- IBC, NFPA, ADAAG Code compliant
- Raised letters and braille
- Peel and stick mounting for easy installation
- Sign should be mounted between 48" - 60" from floor to lowest tactile characters



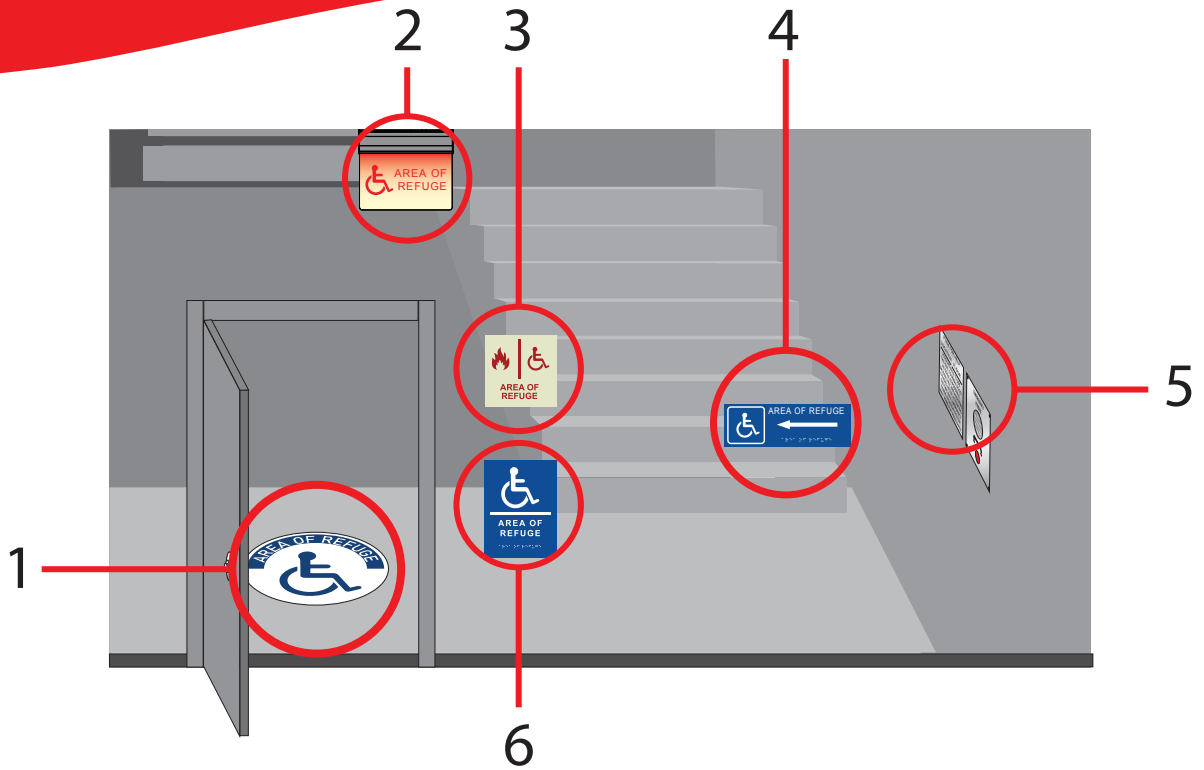

Area of Refuge Signs

## AREA OF REFUGE FLOOR DECAL 17AORFS



- Dimension: 17" diameter
- Self adhesive sign mounts to any smooth, dry, flat & clean surface
- Premium non-slip vinyl overlamination includes pebble-like texturing for safe, slip-resistant design

## AREA OF REFUGE LIT SIGN 1410AORL

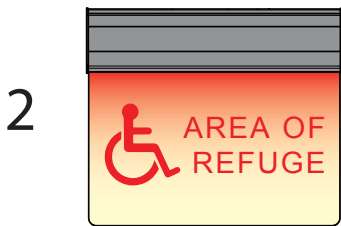

- Dimensions: 10.5"H x 14"W x 3"D
- Single Sided
- Aluminum housing with acrylic surface
- Mounts to any surface (4 screw holes)
- Power: 120/277vac (4w, 350mA)
- Voltage surge and short circuit protection
- Battery backup
- LED lights
- Constant uniform illumination
- Sign should be mounted above 60" but below 80" from the floor to top of the sign
- Directional arrows included (set of 3)
- UL listed to meet UL 924, NEC, OSHA, NFPA, and Life Safety Code Illumination requirements





3

## AREA OF REFUGE PHOTOLUMINESCENT SIGN 88AORGLW



- Dimensions: 7-3/4" H x 7-3/4" W
- Peel and stick mounting for easy installation
- Sign should be mounted above 60" but below 80" from floor to top of sign
- IBC, NFPA, ADAAG Code compliant
- Photoluminescent Material Specifications:
- Base material is PVC and a non-toxic pigment is added to create the photoluminescent effect
- Material is listed under UL 1994
- After being exposed to 1 foot candle of light for 60 minutes, a minimum luminance shall be 30 millicandelas per square meter at 10 minutes and 5 millicandelas per square meter after 90 minutes
- Typical material life expectancy is 25+ years

4

## AREA OF REFUGE TACTILE BRAILLE SIGN W/ARROW 412ARB



- Elevator Landing Tactile Braille Sign
- Dimensions: 4"H x 12"W
- IBC, NFPA, ADAAG Code compliant
- Raised letters and braille
- Peel and stick mounting for easy installation
- Sign should be mounted between 48" - 60" from floor to lowest tactile characters

5

## AREA OF REFUGE PUSH FOR HELP SIGN 1210PFH

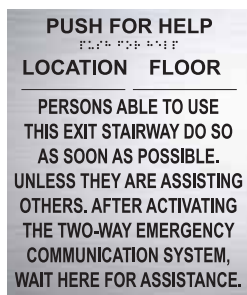

- Dimensions: 12" H x 10" W
- White Finish or Silver Finish
- Raised letters and braille
- All text 5/8" height
- Peel and stick mounting for easy installation
- Sign should be mounted above or adjacent to each Call Box
- Required for each Call Box per IBC Section 1007.1
- IBC, NFPA, ADAAG Code compliant

6

## AREA OF REFUGE TACTILE BRAILLE SIGN 86ARB



- Area of Refuge Tactile Braille Sign
- Dimensions: 8"H x 6"W
- IBC, NFPA, ADAAG Code compliant
- Raised letters and braille
- Peel and stick mounting for easy installation
- Sign should be mounted between 48" - 60" from floor to lowest tactile characters



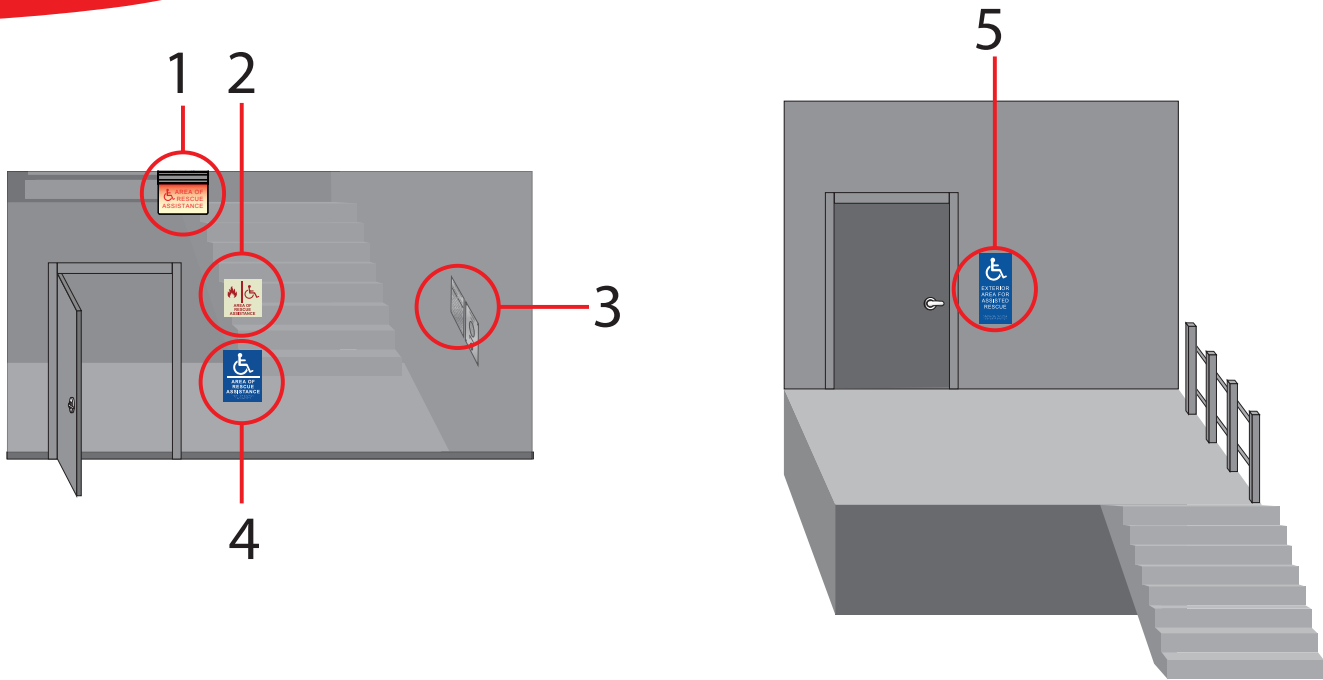

## RESCUE ASSISTANCE LIT SIGN

1410AORAL



- Dimensions: 10.5"H x 14"W x 3"D
- Single Sided
- Aluminum housing with acrylic surface
- Mounts to any surface (4 screw holes)
- Power: 120/277vac (4w, 350mA)
- Voltage surge and short circuit protection
- Battery backup
- LED lights
- Constant uniform illumination
- Sign should be mounted above 60" but below 80" from the floor to top of the sign
- Directional arrows included (set of 3)
- UL listed to meet UL 924, NEC, OSHA, NFPA, and Life Safety Code Illumination requirements

## RESCUE ASSISTANCE PHOTOLUMINESCENT SIGN

88AORAGLOW



- Dimensions: 7-3/4" H x 7-3/4" W
- Peel and stick mounting for easy installation
- Sign should be mounted above 60" but below 80" from floor to top of sign
- IBC, NFPA, ADAAG Code compliant
- Photoluminescent Material Specifications:
  - Base material is PVC and a non-toxic pigment is added to create the photoluminescent effect
  - Material is listed under UL 1994
- After being exposed to 1 foot candle of light for 60 minutes, a minimum luminance shall be 30 millicandelas per square meter at 10 minutes and 5 millicandelas per square meter after 90 minutes
- Typical material life expectancy is 25+ years



## RESCUE ASSISTANCE PUSH FOR HELP SIGN

1210PFH

3

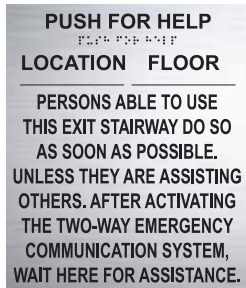

- Dimensions: 12" H x 10" W
- White Finish or Silver Finish
- Raised letters and braille
- All text 5/8" height
- Peel and stick mounting for easy installation
- Sign should be mounted above or adjacent to each Call Box
- Required for each Call Box per IBC Section 1007.1
- IBC, NFPA, ADAAG Code compliant

## RESCUE ASSISTANCE TACTILE BRAILLE SIGN

86AORA

4



- Elevator Landing Tactile Braille Sign
- Dimensions: 6"H x 8"W
- IBC, NFPA, ADAAG Code compliant
- Raised letters and braille
- Peel and stick mounting for easy installation
- Sign should be mounted between 48" - 60" from floor to lowest tactile characters

## EXTERIOR RESCUE ASSISTANCE TACTILE BRAILLE SIGN

115EAORA

5



- Elevator Landing Tactile Braille Sign
- Dimensions: 11"H x 5"W
- IBC, NFPA, ADAAG Code compliant
- Raised letters and braille
- Peel and stick mounting for easy installation
- Sign should be mounted between 48" - 60" from floor to lowest tactile characters





# AREA OF RESCUE SIGNAGE SOLUTIONS



710 E. Western Ave., Lombard, IL 60148  
Phone: 630-359-5929 Fax: 630-359-3043  
[sales@aorsigns.com](mailto:sales@aorsigns.com)